

PLANTA BAJA

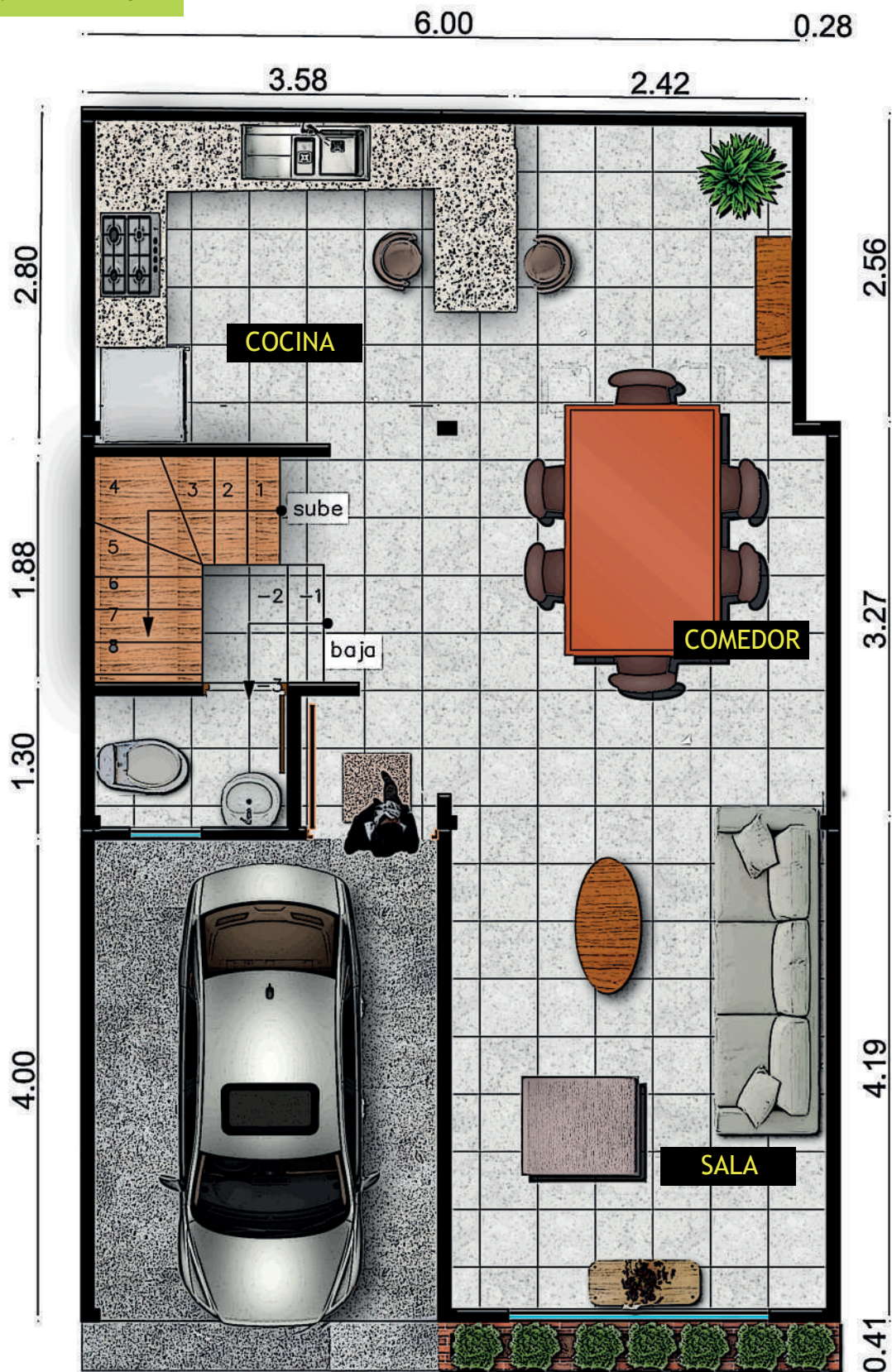

PLANTA ALTA

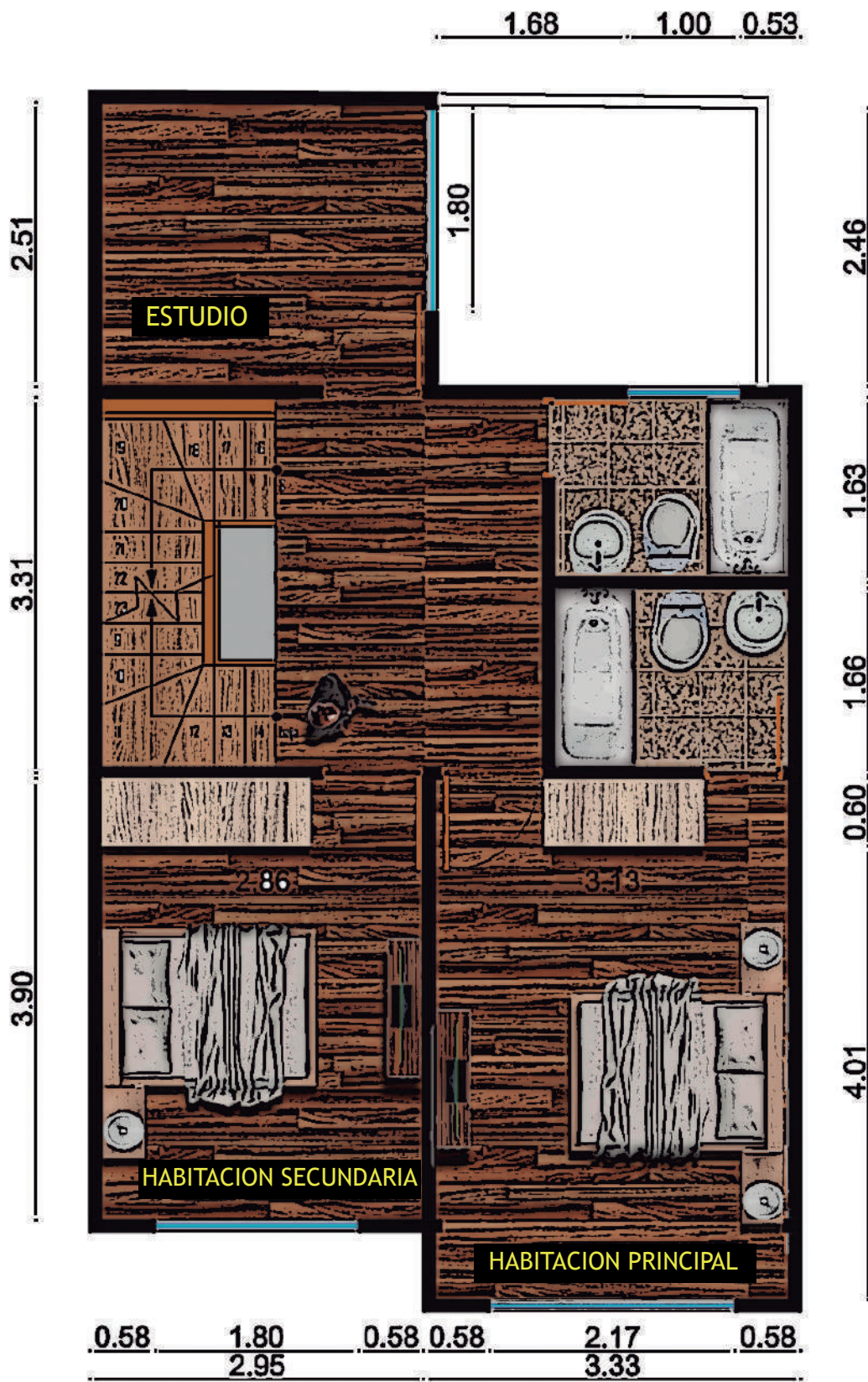

BUHARDILLA

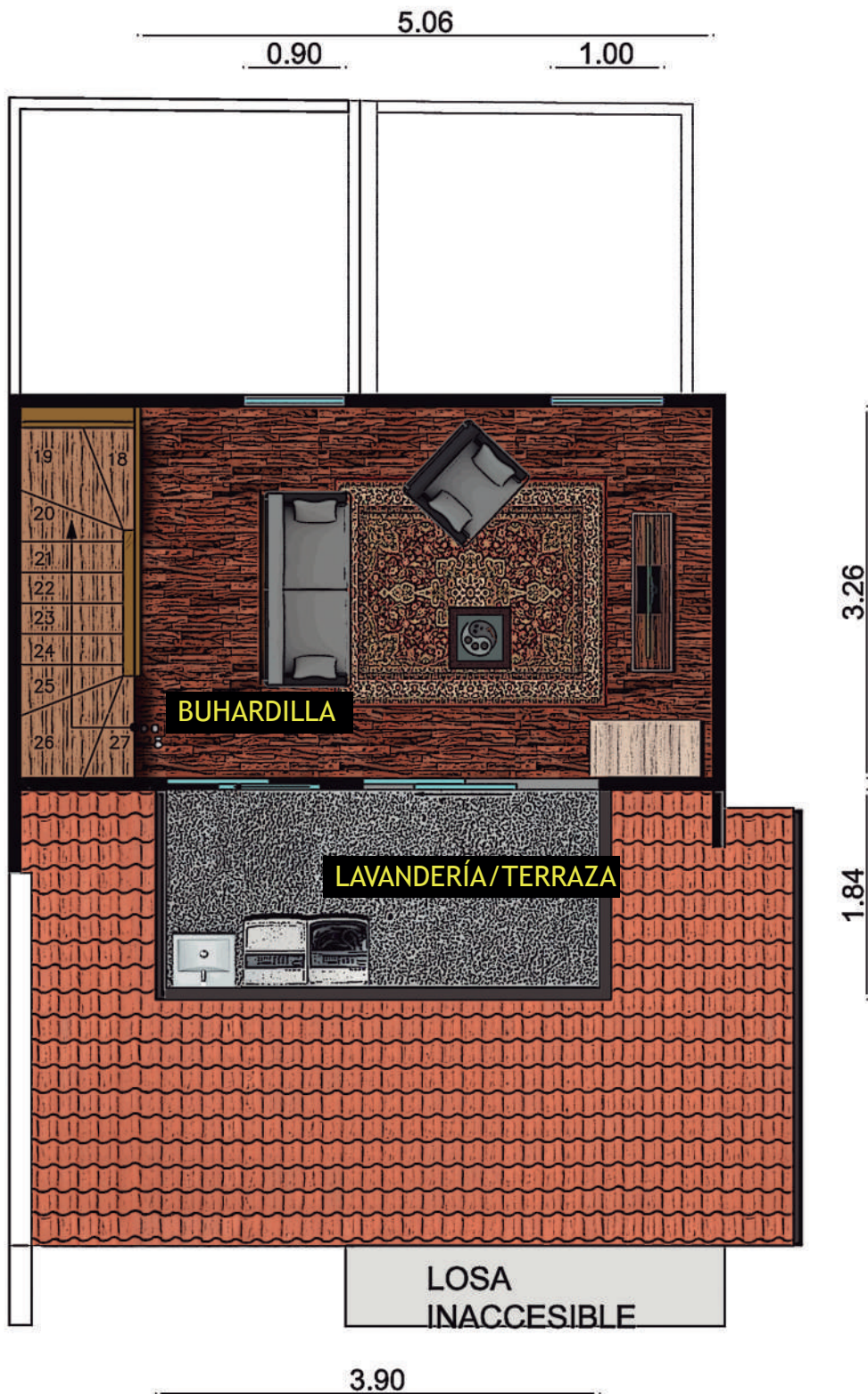

COCINA



COMEDOR



SALA



HABITACION PRINCIPAL



HABITACION SECUNDARIA



BUHARDILLA



LAVANDERÍA



Perspectiva

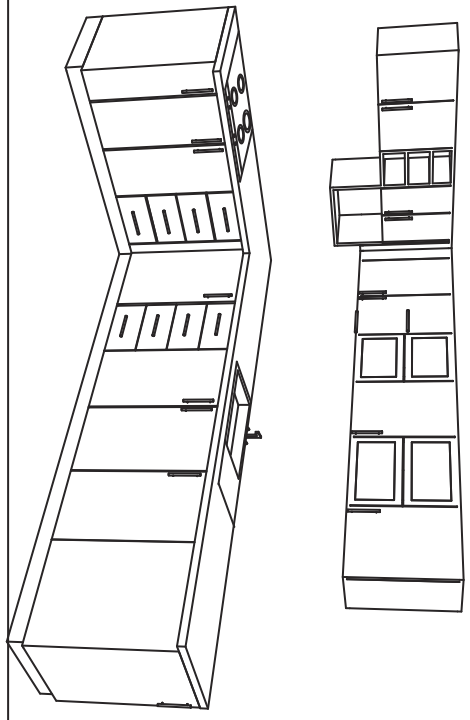

Planta

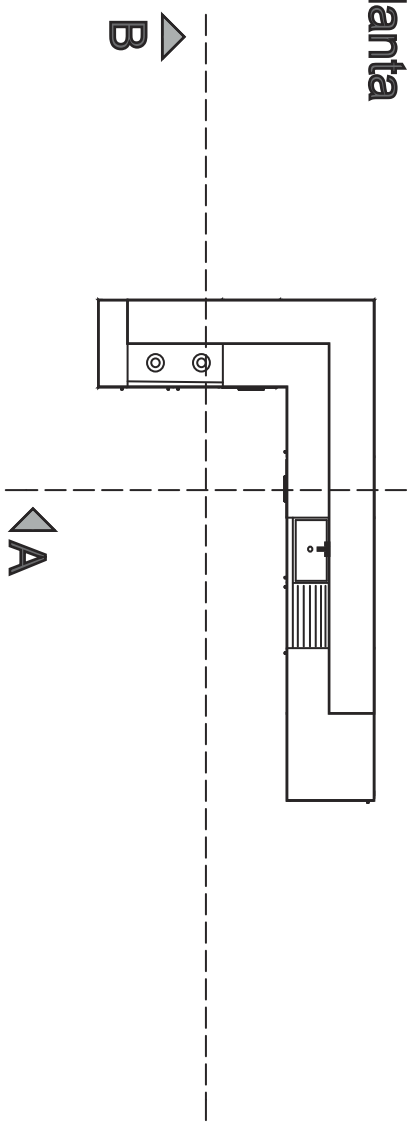

Seccion A

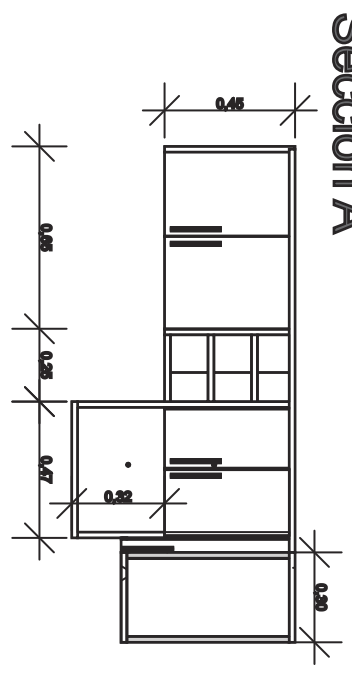

Seccion B

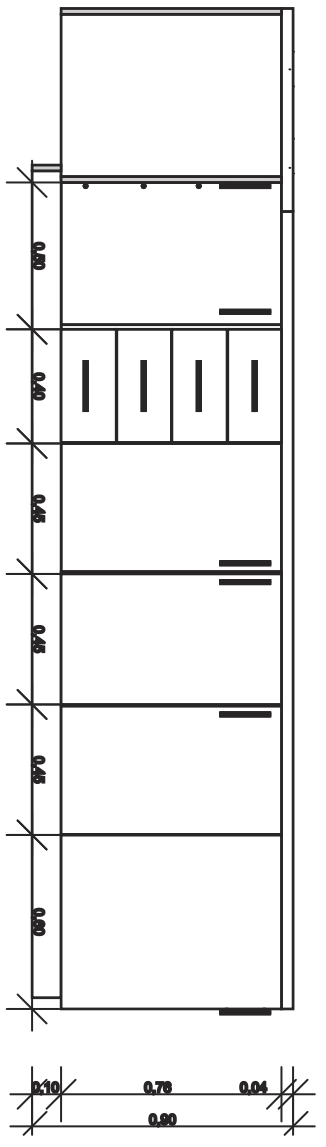
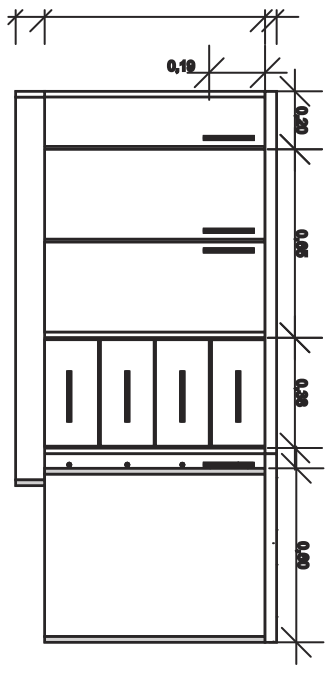
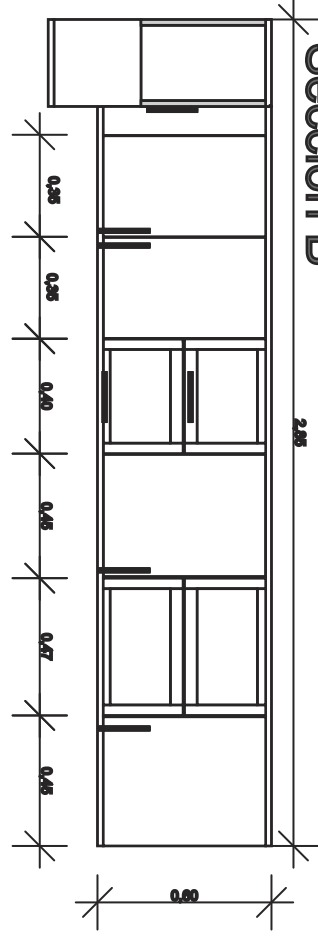

PLANTA

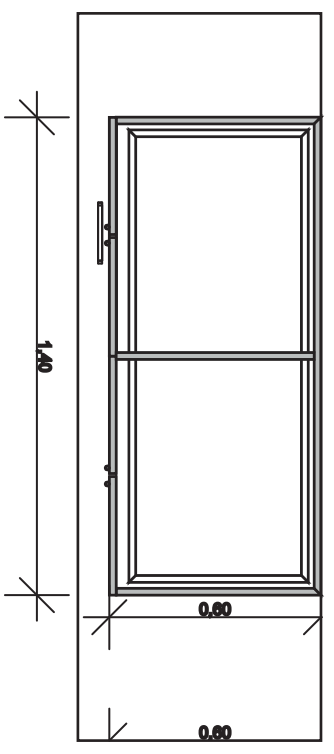

PERSPECTIVA

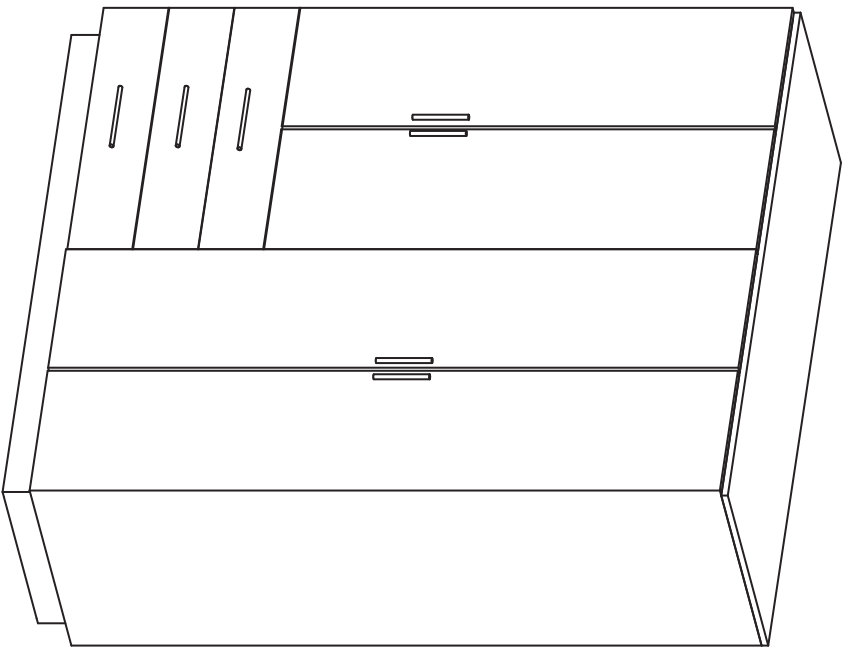

ELEVACION

PERSPECTIVA

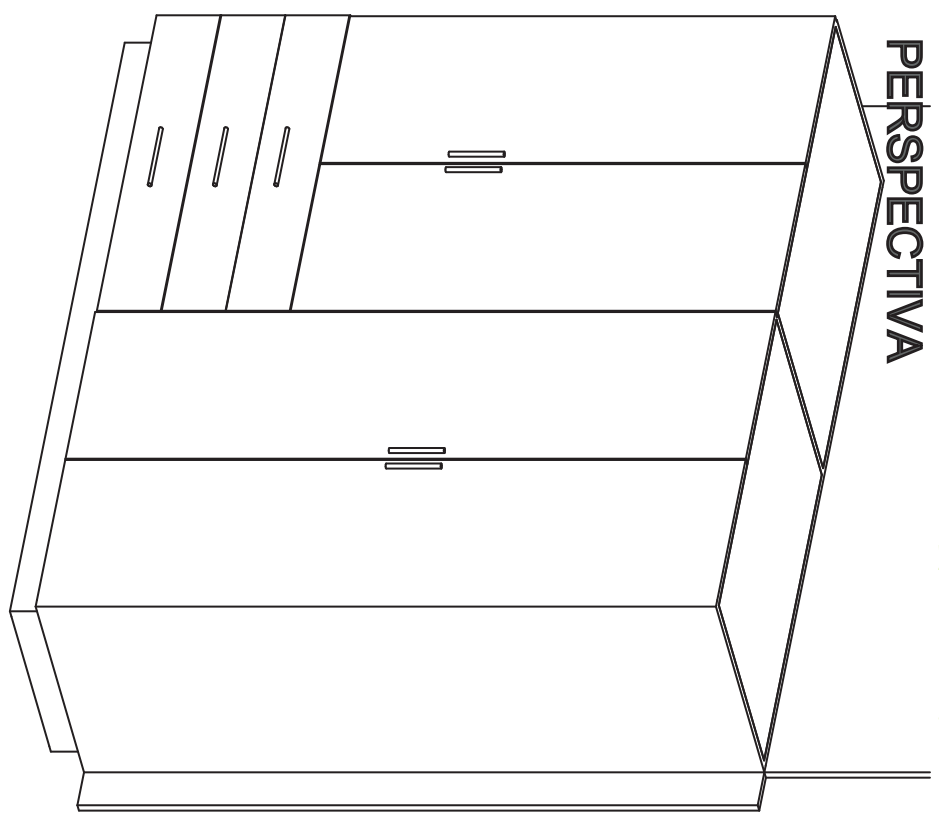

PLANTA

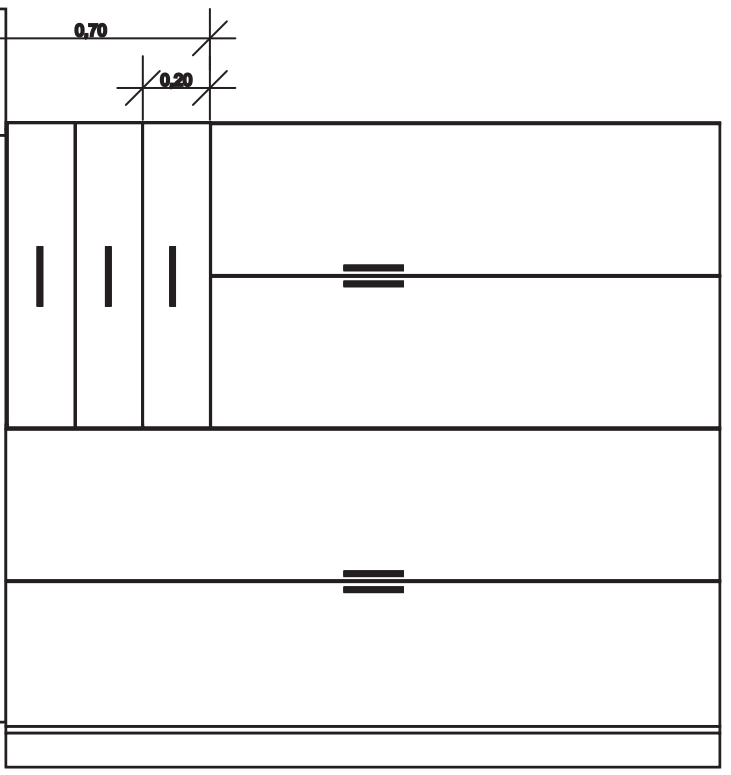
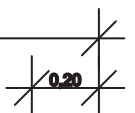
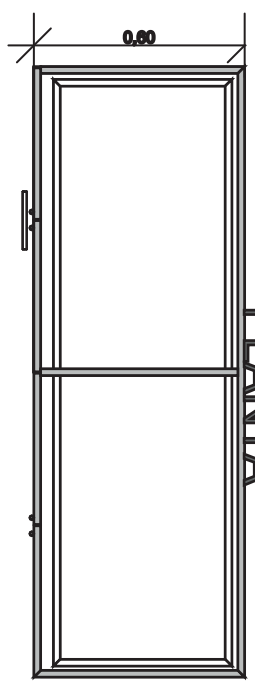

ELEVACION

PERSPECTIVA

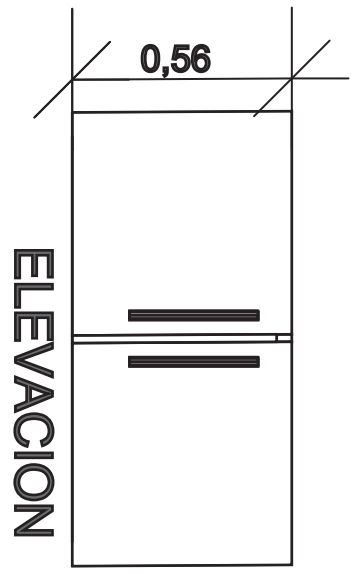
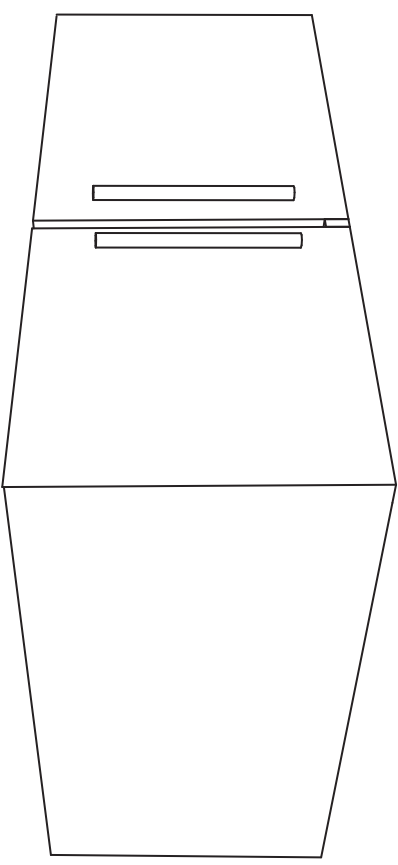

ELEVACION

PLANTA

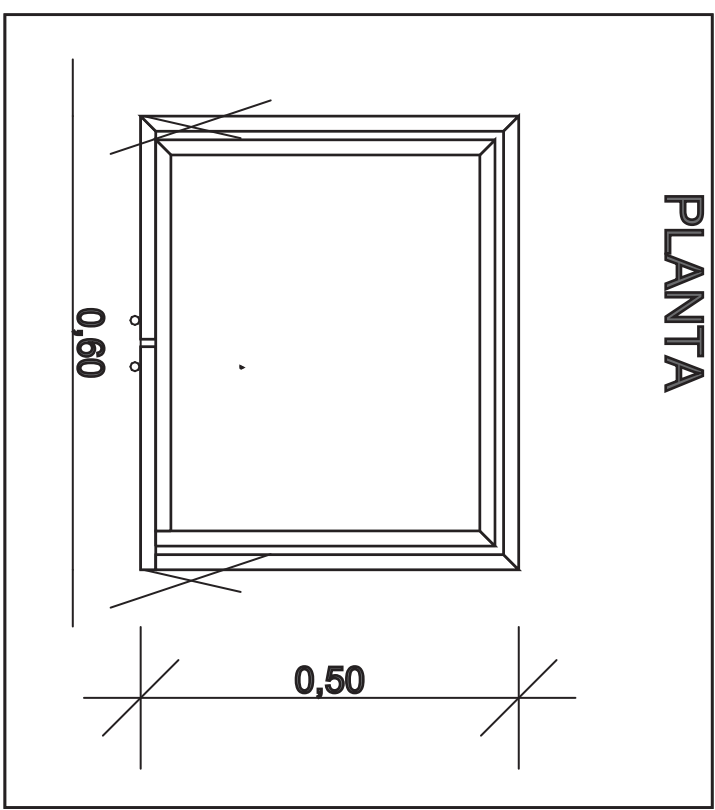

BAÑO SOCIAL

PERSPECTIVA

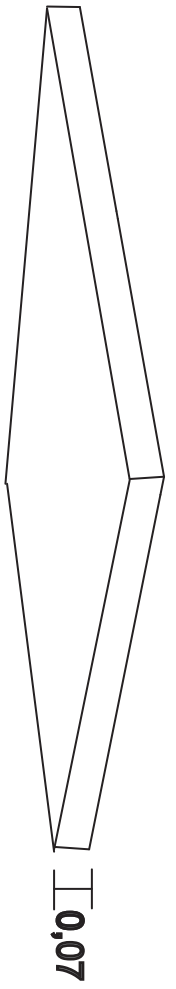

AREA TOTAL

VIVIENDA 1

GARAJE	
PLANATA BAJA	
PLANTA ALTA	
BUHARDILLA	
TERRAZA	
TOTAL	